



BIBCOCKS

139R Drain ball valve with brass hose connection and nylon handle



MEASURE	PRESSURE	CODE	PACKING
3/8" (DN 10)	10bar/145psi	1390038R	20/160
1/2" (DN 15)	10bar/145psi	1390012R	20/160
3/4" (DN 20)	10bar/145psi	1390034R	15/120

CERTIFICATIONS



TECHNICAL SPECIFICATIONS

Body in brass.

Hose connection in brass.

Minimum and maximum working temperatures: -10°C, 90°C.

Threads: ISO228 (equivalent to DIN EN ISO 228 and BS EN ISO 228).

OVERALL DIMENSIONS

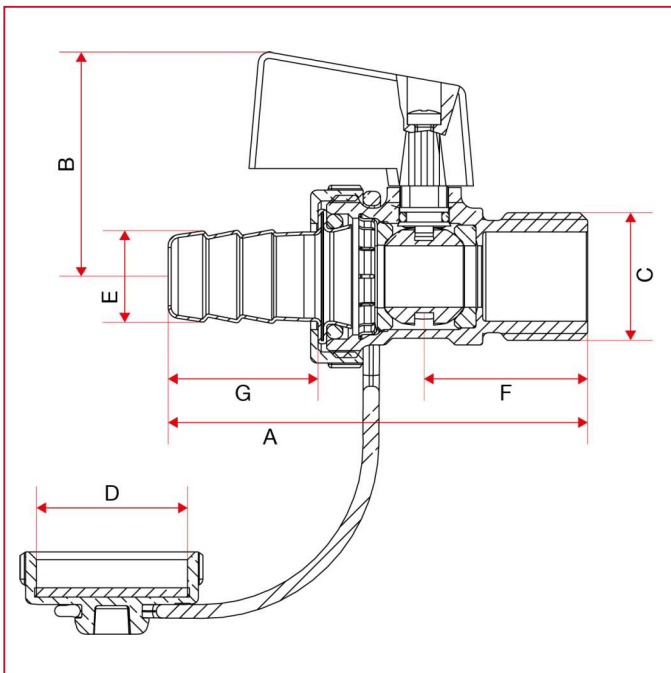



BIBCOCKS

	3/8"	1/2"	3/4"
DN	10	15	20
A	62,2	68	67
B	36,3	36,3	-
C	3/8"	1/2"	3/4"
D	3/4"	3/4"	3/4"
E	15	15	15
F	20,7	26,5	23,7
G	24,3	24,3	24,3
Kg/cm2 bar	10	10	10
LBS - psi	145	145	145

MATERIALS

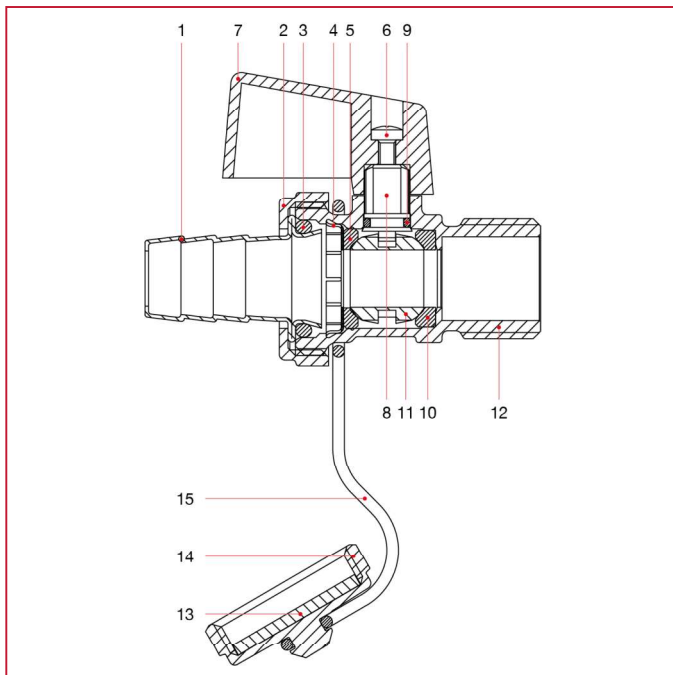

POS.	DESCRIPTION	N.	MATERIAL
1	Hose connection	1	Brass CW508L
2	Nut	1	Brass CW617N
3	O-ring	1	NBR
4	Sleeve	1	Brass CW617N
5	Seat	1	P.T.F.E.
6	Screw	1	Zinc-plated steel
7	Handle	1	Nylon 66
8	Stem	1	Brass CW617N
9	O-ring	1	NBR
10	Seat	1	P.T.F.E.
11	Ball	1	Brass CW617N
12	Body	1	Brass CW617N
13	Washer	1	EPDM
14	Cap	1	Brass CW617N
15	Strap	1	Elastomero